

**ELGi**<sup>®</sup>

Always Better.

# ELGi AIRMATE AIR ACCESSORIES

Total Compressed  
Aircare Solutions



Air Quality and Energy Saving

## COMPRESSED AIR SOLUTIONS FOR ALL SUSTAINABLE AIR NEEDS



**OIL FREE SERIES SCREW**  
45 - 450 kW | 190 - 2601 cfm



**EG SERIES ROTARY SCREW**  
11 - 250 kW | 45 - 1540 cfm



**EN SERIES ROTARY SCREW**  
2.2 - 37 kW | 8.0 - 249 cfm



**PISTON COMPRESSOR**  
5.0 - 30 HP | 15 - 98 cfm



**AIRMATE™**  
AIR ACCESSORIES



With the Conserve Energy Saving Accessories and Airmate Downstream Accessories, ELGi is Striving for a Clean, Greener, and Sustainable Future.

## PREVENT REAL LIFE PROBLEMS WITH ELGi AIRMATE REFRIGERATION AIR DRYERS AND FILTERS



**Real-Life Problem 1**  
Unwanted Abrasive Sludge



**Real-Life Problem 2**  
Corrosion of Piping



**Real-Life Problem 3**  
Damaged Pneumatic Tools

### Why do we need to dry the air?

When atmospheric air cools down, following a compressor compression process, water vapor precipitates as condensate. This is the form of water that is naturally present in the air we breathe. Under average conditions, a compressor with a capacity of 106 cfm at 108 psi will generate approximately 10.5 gal of water per day. This condensate must be removed from the compressed air system to prevent corrosion and damage to transmission piping and end-use machines. Compressed air drying is hence essential and is an important part of the air treatment process.



### Why do we need to filter the air?

Compressed air will also contain water, dirt, wear particles, bacteria, and even degraded lubricating oil. All these impurities mix to form an abrasive sludge. This sludge is often acidic and accelerates wear and tear of tools, pneumatic machinery, block valves, and orifices. This results in expensive air leaks and high maintenance. It also corrodes pipes and can bring the production process to a standstill.

Only compressed air that is completely clean and dry will ensure reliable working of compressed air systems and maximum savings. The favored method of drying the compressed air is through refrigeration dryers and filtering through the downstream filter.

ELGi offers a reliable solution through ELGi Airmate Refrigerant Air Dryers and Filters. The dryers ensure longer life of compressed air systems through the efficient removal of the condensate and contaminants through filters.

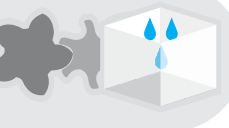
## TOTAL AIR CURE SOLUTIONS FOR CLEAN AND DRY AIR

- 1** Ambient air of 106 cfm at 95°F with 60% RH contains 21.6 gal of water / day
 
- 2** Compression ratio 1:10 working volume of 10.5 cfm at 113°F will precipitate 16.1 gal of water/day & get removed by the moisture separator
 
- 3** ELGi Airmate Refrigerant Dryer will remove 5.0 to 5.3 gal of water/day
 

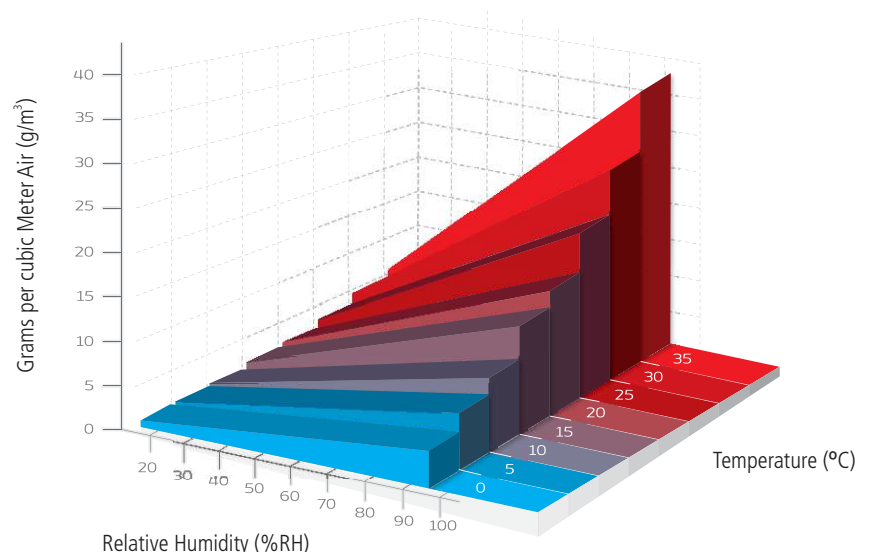



## EGRD REFRIGERANT DRYER

ELGi Global Refrigerated Dryer (EGRD) is suitable for all applications which require constant dew point. EGRD series dryers provide the customers with the best overall value proposition and excellent performance.

The dryer is manufactured in compliance with applicable international standards (UL, CE, CRN) and designed according to international quality standards.

## OVERALL VALUE PROPOSITION



**LOWEST  
PRESSURE DROP**



**LOWEST SPECIFIC  
POWER CONSUMPTION**

## OZONE-FRIENDLY REFRIGERANT

ELGi always strives to deliver products and solutions to make the earth and the environment safer and a better place to live. As per international protocol, ELGi uses ozone-friendly R 134 A and R 407 C gas as the refrigerant, which has zero ozone-depletion potential.



## EGRD REFRIGERATED AIR DRYER SCHEMATIC DIAGRAM

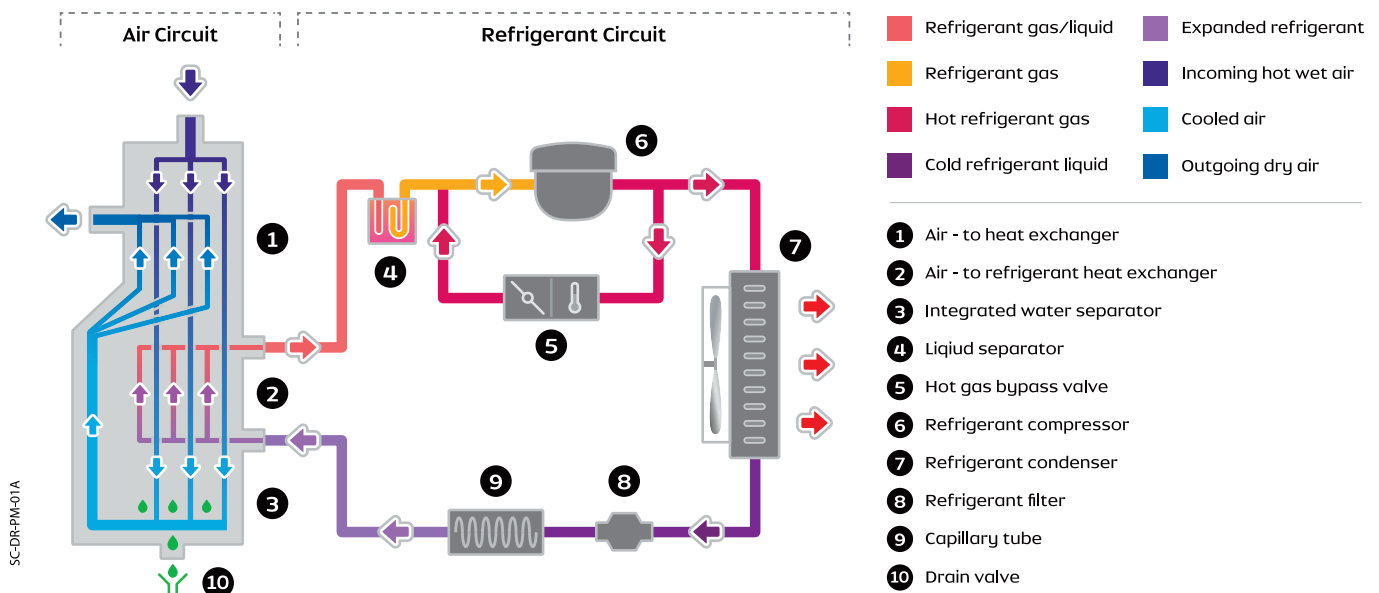

# TECHNICAL SPECIFICATION

How to calculate dryer minimum nominal capacity to meet rated conditions:  
 Dryer nominal capacity need to be higher than "Actual required capacity".  
 (exceeding dryer's nominal capacity, water carry-over could occur)

**Actual rated capacity**  
 F1 X F2 X F3 X F4

ELGi Model	Inlet flow capacity		Max. Working Pressure	Nominal Power Consumption in hp		Compressed Air Connections	Cooling media	Dimensions in Inches			Gross Weight in lbs	
	Scfm	M <sup>3</sup> /min		psi	Air Cooled			Water Cooled	Length	Width	Height	Air Cooled

### Single phase / 115V / 60Hz

EGRD10	10	0.28	232	0.19	-	3/8" NPT	Air	12.19	14.56	17.13	46	-
EGRD15	15	0.42	232	0.20	-	3/8" NPT	Air	12.19	14.56	17.13	48	-
EGRD20	20	0.57	232	0.21	-	1/2" NPT	Air	15.56	20.25	19.69	55	-
EGRD30	35	0.99	232	0.29	-	1/2" NPT	Air	15.56	20.25	19.69	62	-
EGRD40	50	1.42	232	0.30	-	1/2" NPT	Air	15.56	20.25	19.69	70	-
EGRD50	65	1.84	232	0.33	-	1/2" NPT	Air	15.56	20.25	19.69	74	-
EGRD80	75	2.12	203	0.45	-	1" NPT	Air	14.94	16.56	30.50	75	-
EGRD100	100	2.83	203	0.70	-	1-1/4" NPT	Air	14.94	17.50	30.50	86	-
EGRD150	125	3.54	203	1.00	-	1-1/4" NPT	Air	14.94	17.50	30.50	88	-
EGRD175	150	4.25	203	1.05	-	1-1/4" NPT	Air	20.50	17.94	34.06	90	-
EGRD200	175	4.95	203	1.10	-	1-1/2" NPT	Air	23.81	22.81	37.00	119	-

### Single phase / 230V / 60Hz

EGRD150	125	3.54	203	1.05	-	1-1/4" NPT	Air	14.94	17.50	30.50	88	-
EGRD175	175	4.96	203	1.15	-	1-1/4" NPT	Air	20.50	17.94	34.06	90	-
EGRD200	200	5.66	203	1.20	-	1-1/2" NPT	Air	23.81	22.81	37.00	119	-
EGRD250	220	6.23	203	1.25	-	1-1/2" NPT	Air	23.81	22.81	37.00	123	-
EGRD300	300	8.50	203	1.50	-	2" NPT	Air	24.00	24.63	40.56	207	-
EGRD400	375	10.62	203	2.20	-	2" NPT	Air	24.00	24.63	40.56	212	-
EGRD500	480	13.59	203	2.30	-	2-1/2" NPT	Air	28.13	28.56	45.50	317	-

### Three phase / 460V / 60Hz

EGRD200	175	4.96	203	1.22	-	1-1/2" NPT	Air	22.83	21.85	37.00	159	-
EGRD250	220	6.23	203	1.38	-	1-1/2" NPT	Air	22.83	21.85	37.00	176	-
EGRD300	300	8.50	203	1.41	-	2" NPT	Air	24.61	21.85	38.39	238	-
EGRD400	375	10.62	203	2.70	-	2-1/2" NPT	Air	28.54	26.18	43.50	353	-
EGRD500	480	13.59	203	2.97	-	2-1/2" NPT	Air	28.54	26.18	43.50	375	-
EGRD600	600	16.99	203	2.65	2.27	ANSI 3" #150	Air/water	35.17	39.38	65.63	529	496
EGRD750	800	22.65	203	3.25	2.92	ANSI 3" #150	Air/water	35.17	39.38	65.63	534	500
EGRD900	900	25.49	203	3.90	3.40	ANSI 3" #150	Air/water	35.17	39.38	65.63	606	564
EGRD1100	1000	28.32	203	4.60	3.75	ANSI 3" #150	Air/water	35.17	39.38	65.63	608	567
EGRD1254	1250	35.40	203	5.60	4.90	ANSI 3" #150	Air/water	35.17	39.38	65.63	686	635
EGRD1552	1500	42.48	203	6.40	5.00	ANSI 4" #150	Air/water	44.69	49.81	68.88	1,021	950
EGRD1750	1750	49.55	203	7.50	5.90	ANSI 4" #150	Air/water	44.69	49.81	68.88	1,186	1,098
EGRD2000	2000	56.63	203	8.60	7.20	ANSI 4" #150	Air/water	44.69	49.81	68.88	1,190	1,102
EGRD2900	2500	70.79	203	9.80	8.40	ANSI 4" #150	Air/water	44.69	49.81	68.88	1,349	1,239
EGRD3000	3000	84.95	203	12.20	9.80	ANSI 6" #150	Air/water	51.19	71.25	71.25	1,830	1,698
EGRD4000	4000	113.27	203	15.70	12.50	ANSI 8" #150	Air/water	55.13	89.00	73.63	2,330	2,326
EGRD5000	5000	141.58	203	23.50	20.00	ANSI 8" #150	Air/water	55.13	89.00	73.63	2,650	2,646
EGRD6000	6000	169.90	203	25.50	22.10	ANSI 8" #150	Air/water	60.88	88.31	96.00	3,640	3,420
EGRD7500	7500	212.38	203	27.10	23.70	ANSI 8" #150	Air/water	60.88	88.31	96.00	4,030	3,750
EGRD8000	8000	226.53	203	35.00	29.80	ANSI 10" #150	Air/water	61.94	111.31	96.63	4,730	4,400
EGRD10000	10000	283.17	203	40.70	35.40	ANSI 10" #150	Air/water	61.94	111.31	96.63	5,390	5,060

**Note:**

- Reference Condition for Inlet flow capacity: 1. Ambient Temperature - 100°F / 2. Inlet compressed air temperature 100°F / 3. Inlet Pressure - 100 psig
- 575V Range Available on request
- All data mentioned above is measured according to ISO 7183, with standard voltages, at 38-41° F dew point
- High pressure dryers and high ambient temperature dryers are available on request.
- Standard scope of supply includes only electronic drain valves up to EGRD500 & zero loss drains from EGRD600

Correction Factors									
<b>Inlet Air Pressure - F1</b>	Psi	60	80	100	120	140	160	180	203
EGRD 10 - 10000		0.79	0.91	1.00	1.07	1.13	1.18	1.23	1.27
<b>Ambient Temperature - F2</b>	°F	<80	90	95	100	105	110	115	120
EGRD 10 - 500		1.10	1.07	1.04	1.00	0.93	0.83	0.70	
EGRD 600 - 10000		1.11	1.09	1.06	1.00	0.94	0.87	0.78	0.69
<b>Inlet Air Temperature - F3</b>	°F	<90	100	110	122	130	140	150	158
EGRD 10 - 500		1.11	1.00	0.82	0.65	0.53			
EGRD 600 - 10000		1.16	1.00	0.82	0.68	0.61	0.52	0.45	0.40
<b>Dew point factor - F4</b>	°F	38	41	45	50				
EGRD 10 - 500		0.92	1.00	1.07	1.25				
EGRD 600 - 10000		1.00	1.08	1.20	1.36				

# Due to continuous improvements the specifications are subject to change without notice



## AIRMATE FILTERS

ELGi's Airmate Filter (AF) is suitable for all applications which require filtered air for reliable performance. AF series filters provide the customer with best-in-class filtration and the lowest pressure drop. The filters are manufactured in compliance with applicable international standards (ASME, CE, CRN) and designed according to international quality standards.

### OVERALL VALUE PROPOSITION:



**Best-in-Class Performance**



**Best-in-Class Energy Efficiency**



**Best-in-Class Warranty**

### COALESCING FILTER

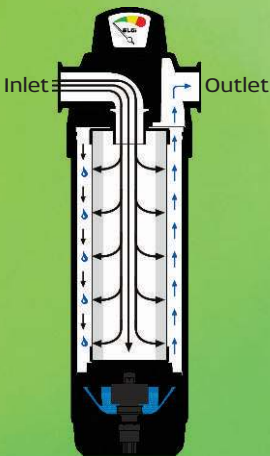

### CARBON FILTER

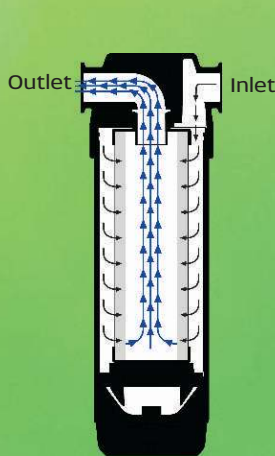

Technical Data	Coalescing pre	Coalescing fine	Activated Carbon
Filter type	P	F	C
Particle removal (micron)	1	0.1	-
Max. oil carry over (mg/m <sup>3</sup> )	0.1	0.01	0.003
Min. recommended temperature	38°F		
Max. recommended temperature	176 °F		122 °F
Initial dry pressure loss	1.16 psi	1.45 psi	1.16 psi
Initial wet pressure loss	1.45 psi	2.39 psi	-
Pressure loss for element change	10.15 psi		
Recommended replacement of elements (Whichever is earliest)	12 months or when the DP Gauge indicates red		6 months
Precede	Type F with type P		Type C with type P, F

\* Filter type C will not remove certain gases and is not recommended for medical air application usage without using suitable medical grade filter

\* Air inlet temperature should be 77°F for filtration of 0.003 mg/m<sup>3</sup> quality oil in the air

\* Maximum oil carry over for Pre and Fine filter at 70°F

# AIRMATE FILTERS

Model (P-F-C)	End connections*	Flow rate @7 barg (100 psig)		Product Dimension										Net Weight (Dry condition)	Max. operating pressure
				H1		W		G		D		H2			
				cfm	m <sup>3</sup> /min	mm	inch	mm	inch	mm	inch	mm	inch		
AF 0021	3/8"	21	0.59	214	8.43	90	3.54	36.5	1.44	19	0.75	192	7.56	2.3	290
AF 0041	1/2"	41	1.16	273	10.75	128	5.04	45	1.77	32	1.26	250	9.82	5.1	290
AF 0059	1/2"	59	1.67	303	11.91	128	5.04	45	1.77	32	1.26	279	10.98	4.4	290
AF 0074	1/2"	74	2.10	343	13.50	128	5.04	45	1.77	32	1.26	320	12.58	5.9	290
AF 0088	1"	88	2.49	369	14.53	140	5.51	45	1.77	31	1.22	335	13.17	7.3	290
AF 0132	1"	132	3.74	398	15.67	140	5.51	45	1.77	31	1.22	365	14.35	7.1	290
AF 0177	1 1/4"	177	5.01	474	18.66	140	5.51	45	1.77	31	1.22	433	17.03	10.5	290
AF 0235	1 1/4"	235	6.65	567	22.20	140	5.51	45	1.77	31	1.22	522	20.55	12.3	290
AF 0294	1 1/2"	294	8.33	511	20.12	151	5.94	45	1.77	25	0.98	465	18.29	12.0	290
AF 0420	1 1/2"	420	11.89	696	27.40	151	5.94	45	1.77	25	0.98	650	25.57	15.1	290
AF 0520	1 1/2"	520	14.72	851	33.50	151	5.94	45	1.77	25	0.98	805	31.67	17.6	290
AF 0620	1 1/2"	620	17.56	976	38.43	151	5.94	45	1.77	25	0.98	930	36.59	20.2	290
AF 0912	2 1/2"	912	25.82	707	27.83	240	9.45	45	1.77	25	0.98	660	25.96	34.8	290
AF 1177	3"	1177	33.33	862	33.93	240	9.45	45	1.77	25	0.98	814	32.06	40.7	290
AF 1589	3"	1589	45.00	987	38.35	240	9.45	45	1.77	25	0.98	939	36.98	45.3	290
AF 2001	DN100 / 4"	2001	56.66	871	34.29	360	14.17	45	1.77	30	1.18	810	31.89	63.6	150
AF 3178	DN100 / 4"	3178	89.99	1070	42.13	360	14.17	45	1.77	30	1.18	1009	39.72	74.4	150
AF 6475	DN200 / 8"	6475	183.35	1579	62.16	786	30.94	-	-	-	-	-	-	825	203

- \*NPT & BSP end connections available, for flange filters ANSI/ DIN standard connections available
- Differential pressure gauge and internal float drain are standard only for pre and fine filters
- For any product selection outside standard catalogue, contact sales
- For flow rate other than 7barg(100psig), use correction factor from below table

## AIRMATE FILTERS CORRECTION FACTOR

For a flow rate other than 7 barg (100 psig), use the correction factor below.

Inlet Air Pressure - F1	psig	1	3	5	7	9	11	13	15	16	18	20
Correction factor		0.5	0.71	0.87	1	1.12	1.22	1.32	1.44	1.5	1.57	1.63

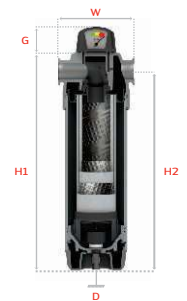

## ADD-ON OPTIONS

**CLAMP**  
Connect two filters easily without any pipes.

**WALL MOUNTING KIT**  
Wall mounting kits are available to connect the filters to the wall easily.

**ZERO LOSS DRAIN**  
Only condensate is drained with an external level sensing drain, and there is no air loss (energy saving). Both mechanical and electronic drain options are available.



## AIRMATE DRAIN VALVES

### “Zero Loss Advantage”

Compressed air condenses moisture in dryers, aftercoolers, and air receivers. This condensate needs to be removed frequently. This process is done by the drain valves. In ordinary drains, there is always a loss of compressed air. Most of the condensate drains have a 4 mm orifice. This 4 mm orifice bleeds about 34 cfm, which is the equivalent of 6.5 kW of power. ELGi Airmate drains work on the principle of zero air loss and do not bleed your compressed air, consequently saving energy.

### ELZ Drain Valve

The condensate sensing type automatic drain valve is the latest advancement in drain valve technology. Instead of operating through a cycle timer, these valves sense the condensate level for activation, ensuring absolutely no loss of compressed air and hence enormous energy saving. These drain valves are highly efficient and reliable. They can be fitted directly on the equipment simply by replacing the manual drains.

- The electronic level control ensures proper draining of condensate and avoids the unnecessary loss of air.
- All the functions of the valve are accurately indicated by the LED display.
- Test switch (or) manual drain allows function test at any time.
- Intelligent Controller detects valve, probe failure and acts accordingly.
- Noise-free, as air is not discharged.

Model	Max. compressor capacity	No. of Inlet Ports	Inlet & Outlet port size	Dimensions (LxBxH)	Max. working pressure
	cfm	Nos	Inch	Inch	psi
EZL 10	350	1	1/2" x 1/4"	4.84x3.62x2.91	232
EZL 100	3500	3	1/2" x 1/4"	3.53x7.05x4.49	232



## OIL-WATER SEPERATOR

When the air is compressed through the compressor, it results in condensate and compressed air: condensate is a mix of water, oil, and dust particles. If not appropriately treated and released into the environment, this condensate can have detrimental effects on the environment. Regulatory bodies for effluent treatment recommend that this condensate be cleansed before releasing it to sewage disposal.

ELGi EOS series is specifically designed to maintain less than 10ppm of oil in the condensate before allowing the fluid to pass on to the environment. The multi-level separation process with super-efficient fiber adsorbent and activated carbon ensures the contaminant levels are kept well within the statutory requirements.

Large compressor systems might require two or more oil/water separators to be installed to match the total compressor capacity of an installation. To connect the oil/water separators and ensure an even condensate distribution into the oil/water separators, you require the Distributor.

The Distributor has two 1" condensate inlets and six 1/2" outlets with integrated ball valves, allowing you to connect two and up to six oil/water separators.



**Distributor**

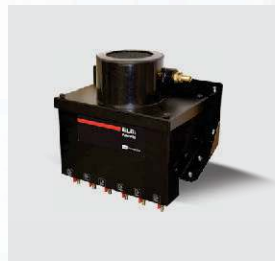

**Mini Distributor**



**Multi-Inlet Adapter**



## TECHNICAL SPECIFICATIONS

Model	Maximum Compressor Capacity	Maximum Oil adsorption capacity	No.of Inlet / Outlet Port	Inlet hose barb (Inner dia.)	Outlet hose barb (Inner dia.)	Package Dimensions (LxBxH)	Gross Weight (Empty)
	cfm	gallon	Nos	Inch	Inch	Inch	lbs
EOS - 7	70	0.52	1	0.40	0.55	10x9x9.9	7
EOS - 13	130	0.8	1	0.40	0.55	15.6x9.5x15.2	13
EOS - 18	175	1.32	1	0.40	1	22.8x7.5x24	22
EOS - 35	350	2.64	1	0.40	1	25.6x9.5x29.5	37
EOS - 70	750	3.96	1	0.40	1	30.7x12x35.4	66
EOS - 110	1250	7.91	1	0.40	1	38.1x15x35.4	95
EOS - 210	2500	13.2	1	0.40	1	45.7x18.9x41	163

# UPTIME<sup>™</sup> MANAGER

In multiple compressor installations, it isn't easy to choose the correct combination of compressors manually. This results in wastage of 20 - 60% of the power. To cut such operating costs, we bring in the Uptime Manager Supply-Side Controller.

The controller can manage any number of positive displacement compressors including compressors of different capacities, different types (fixed speed, variable speed, and variable capacity), and in any combination or configuration. Through advanced control functionality and universal connectivity, the Uptime Manager will work with your existing compressors, from ELGi or any manufacturer, to improve operating efficiency and reduce energy costs. Here's how the Uptime Manager controller delivers a unique combination of efficiency and reliability:

- Operate compressors only as needed, bringing standby compressors online incrementally during periods of increased demand.
- Dynamically match the most energy-efficient compressor or combination of compressors with compressed air demand.
- Manage the compressed air system at your minimum required pressure without compromising the reliability of your compressed air supply.

## UPTIME MANAGER BRINGS ENERGY EFFICIENCY

Running a compressor in standby mode (unloaded) to ensure maximum capacity when needed uses approximately 25% or more of the energy required to run that same compressor fully loaded. Systems with multiple compressors of varying sizes, types, and configurations further complicate manual coordination and maintaining the correct compressor settings. The larger the system, the more will be the unproductive energy cost!

The Uptime Manager eliminates the complexity of compressor control coordination and increases energy efficiency. Only the specific compressors operate at a given time. Other compressors used for normal operations with manual control will be kept offline and shall be available during emergency requirements or during primary equipment breakdown. This ability to tap existing resources to maintain system operation even in emergencies makes the system more reliable. In addition to optimizing energy usage, efficient compressor utilization reduces costs due to less downtime.

## MANAGE YOUR BATTERY OF AIR COMPRESSORS EFFICIENTLY

The primary functions of Energy Control Mode in Uptime Manager are:

- Match compressed air supply to compressed air demand dynamically.
- Utilize the most energy-efficient combination of air compressors to satisfy demand.
- Manage multiple compressors at the minimum required pressure band.



### Additional Energy Consumption Conventional Cascade - Large Pressure band

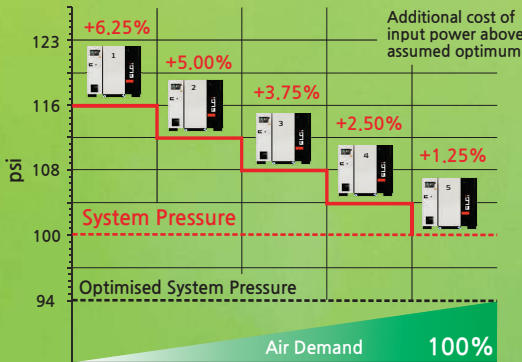

### Pressure Optimization using UM - Minimised Pressure band

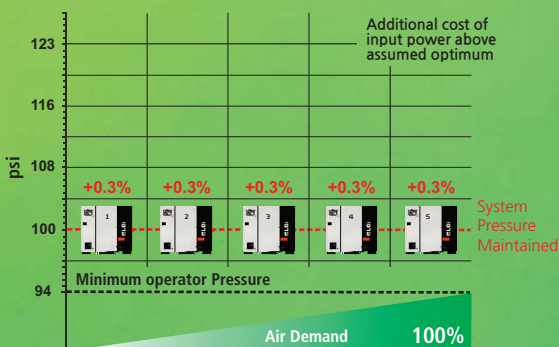

## Connectivity, Communication, and Control at the Heart of Your Air System

ELGi's Uptime Manager is one air system control solution that quickly pays for itself without compromising any of your previous capital investments on the compressor or air system.

<b>SINGLE-POINT CONTROL</b>	<b>PRIORITY COMPRESSOR SELECTION</b>	<b>REAL-TIME SYSTEM SCHEDULING</b>	<b>CONTROLLED OPERATIONS</b>	<b>SYSTEM PREFILL</b>
Manage multiple compressors to one optimal control band or target. Single controller with programmable logic controls all compressors in a compressor house or common header.	Minimize energy use by programming units or groups for optimum utilization and/or operations planning including equalized usage. For example, you can now prioritize more efficient compressors as lead compressors or VFD-driven compressors for trim requirements.	Configure control features, including system standby and system prefill on a real-time schedule.	Fully adjustable time parameters help implement smooth, controlled schedule changes from one target pressure level to another.	Will prevent all compressors from starting simultaneously after the system has been shut down for a while.

<b>UPTIME Manager</b>	<b>UM4</b>	<b>UM12</b>	<b>UM24</b>
<b>Maximum number of Compressor:</b>			
4 no.	✓	✓	✓
12 no.		✓	✓
24 no.			✓
<b>Type of Compressor regulation:</b>			
Fixed Speed Compressor	✓	✓	✓
Variable Frequency Compressor		✓	✓
Variable Displacement Compressor		✓	✓
<b>Operating Mode:</b>			
Timer Rotation	✓	✓	✓
Equal Running Hours	✓	✓	✓
FIFO	✓		
Energy Control		✓	✓
<b>UPTIME Manager Functions:</b>			
Priority Selection	✓	✓	✓
System Pre-fill	✓	✓	✓
Pressure Balancing (for multiple Compressor rooms)			✓
Zone Control (for multiple compressor rooms)			✓
<b>Inbuilt Real Time Clock:</b>			
Schedule to Start/Stop System	✓	✓	✓
Pressure Band Change (through table technology)	✓	✓	✓
Compressor Priority Change (through table technology)	✓	✓	✓
Operating Mode Change (through table technology)	✓	✓	✓

Note: For helping you understand the right solution for your compressor house contact sales.

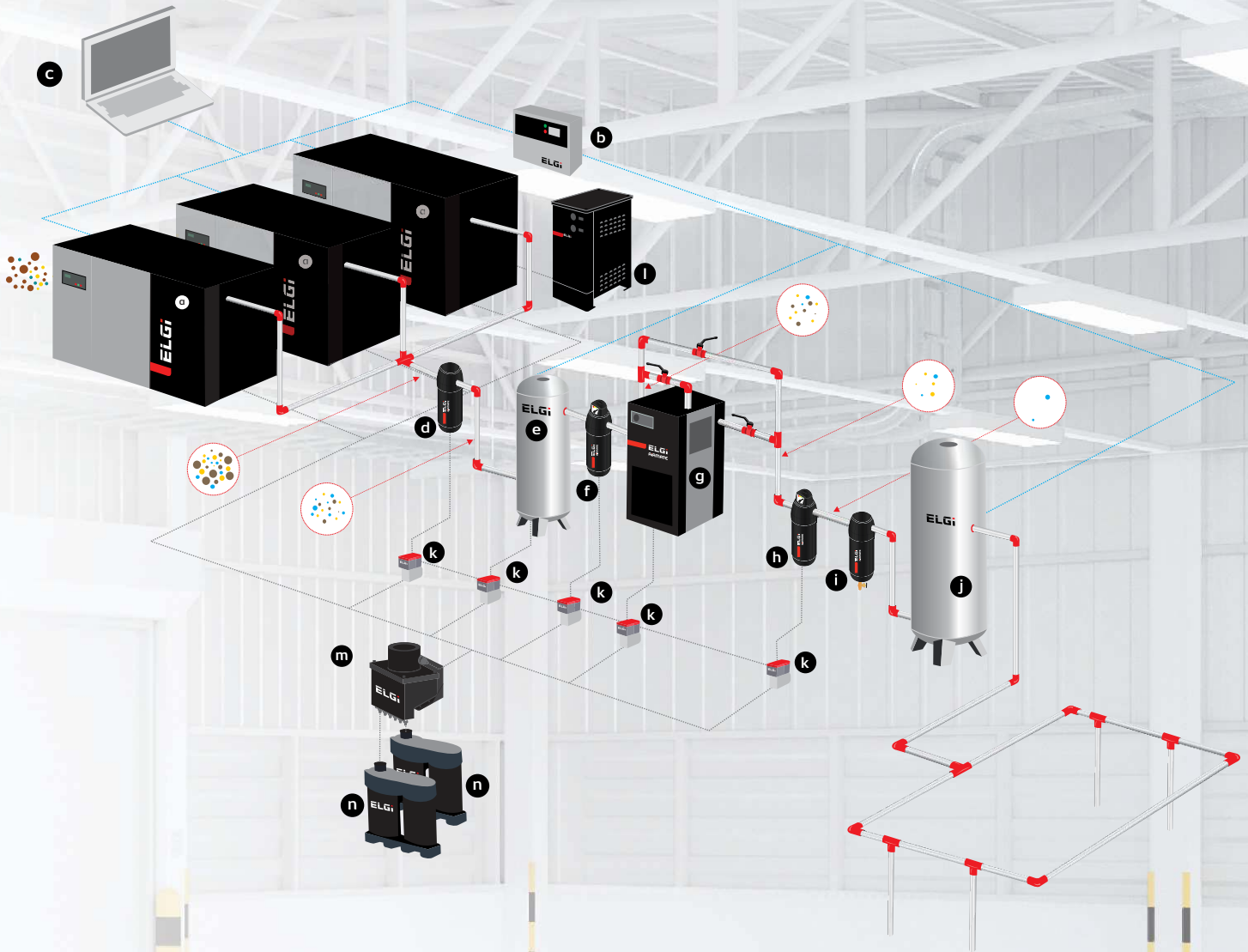

## TYPICAL COMPRESSED AIR SUPPLY SYSTEM

- a. EG Series Compressor
- b. UPTIME Manager
- c. Remote-Central Control
- d. Moisture Separator
- e. Airmate Receiver wet

- f. Airmate Filter - Pre Coalescing
- g. EGRD Refrigerant Dryer
- h. Airmate Filter - Fine Coalescing
- i. Airmate Filter - Carbon
- j. Airmate Receiver Dry

- k. Drain Valve
- l. Heat Recovery System
- m. MAXI Distributor
- n. EOS - Oil Water Separator

- Dust Particles
- Oil
- Moisture